

Email:sales01@dck-gd.com

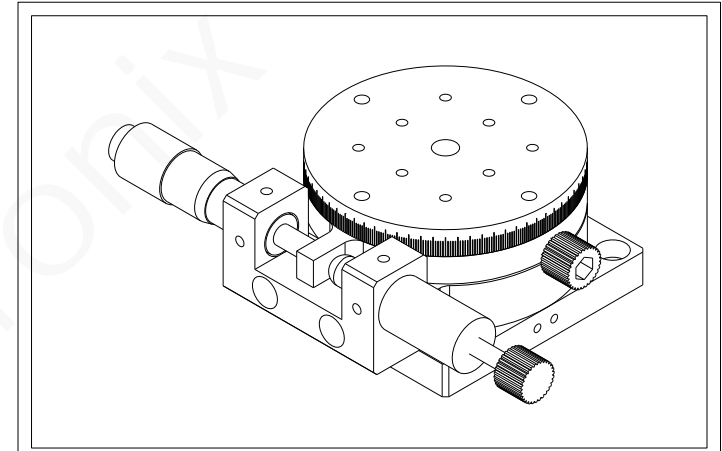

Model	JCRT-60L
Surface Size	Ø 60 mm
Position of Micrometer Head	Left
Travel Range	Coarse: Ø360° Fine: ±5°
Minimum Reading of Micrometer	10um
Readable Resolution	1°
Load Capacity	8.0Kgf
Parallelism	30um
Rotational Concentricity	30um
Weight	0.5Kg
Material	Aluminum
Finish Treatment	Black Anodizing

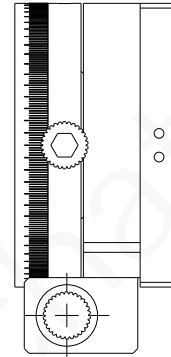
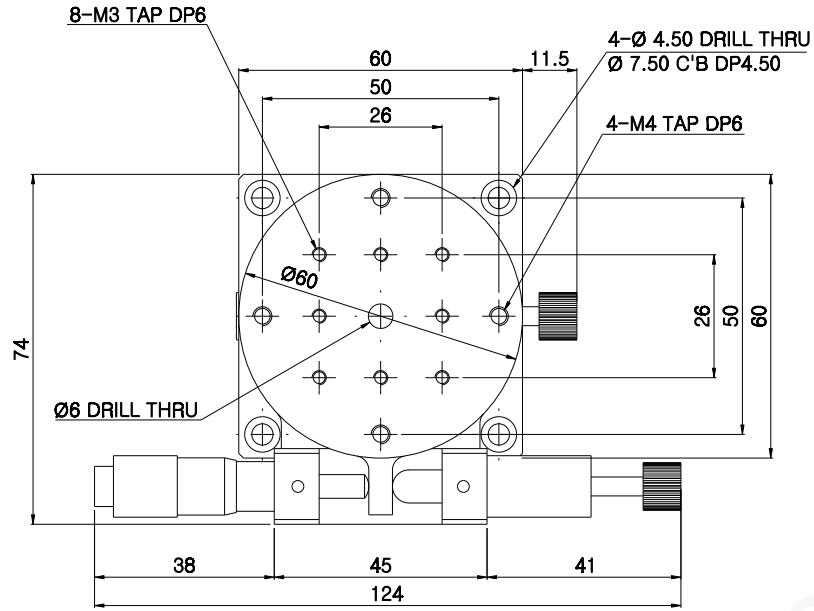
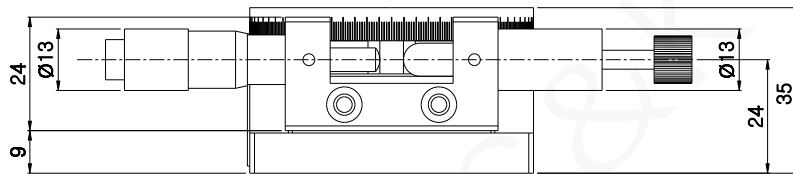

JCRT - 60L

东莞市诚鲲五金电子科技有限公司

Email:sales01@dck-gd.com

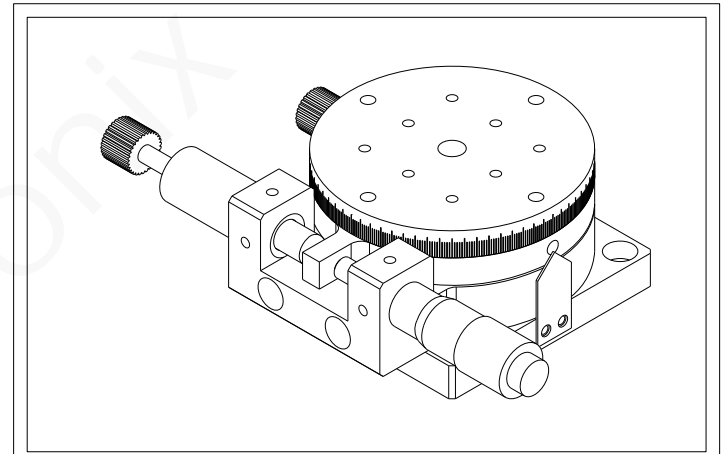

Model	JCRT-60R
Surface Size	Ø 60 mm
Position of Micrometer Head	Right
Travel Range	Coarse: Ø360° Fine: ±5°
Minimum Reading of Micrometer	10um
Guide Type	1°
Load Capacity	8.0Kgf
Parallelism	30um
Driving Parallelism	30um
Weight	0.5Kg
Material	Aluminum
Finish Treatment	Black Anodizing

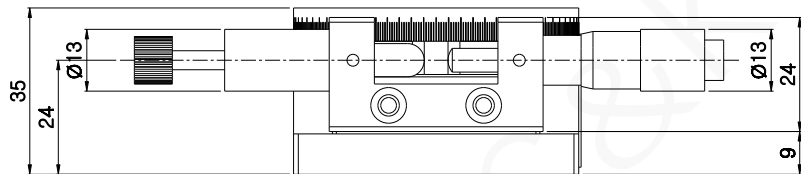
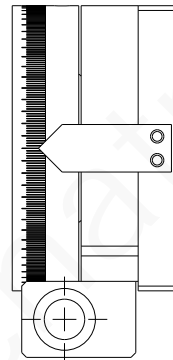
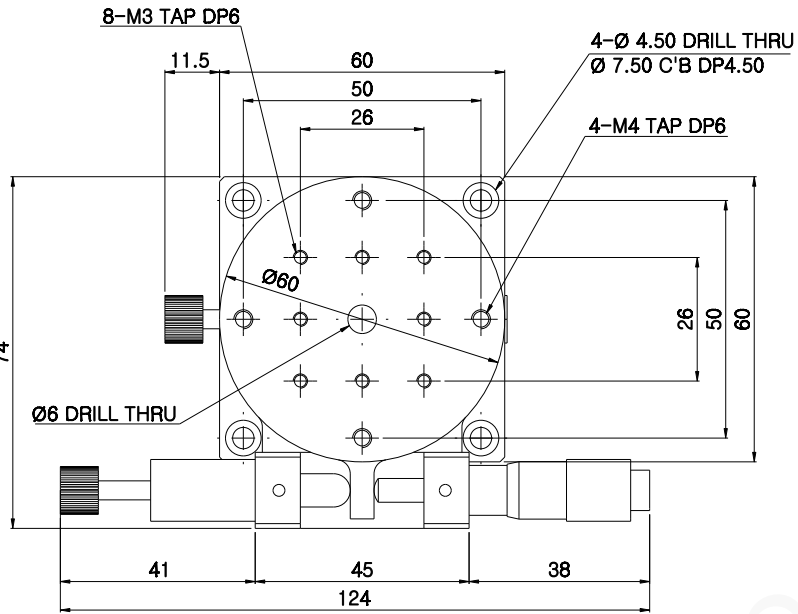

JCRT - 60R

东莞市诚鲲五金电子科技有限公司